

**Produs:**  
**ZEN 66 TIA**



Racire cu lichid



50 Hz



Trifazat



Diesel



GRUP ELECTROGEN DIESEL 66 TIA	STANDBY POWER (ESP)	PRIME POWER (PRP)
Putere (kVA)	66	60
Putere (kW)	52	46
Turatie (rpm)	1500	
Tensiune standard (V)	400 / 230	
Factor putere (cos phi)	0,8	
Amperaj (Amp)	87	

**Certificari Endress Zenessis Group S.R.L.:**  
ISO 9001 : 2008, ISO 14001 : 2005, ISO 18001 : 2008.

**Grupurile electrogene ZENESSIS sunt conforme CE, si sunt testate conform legislatiei EU privind nivelul de zgomot 2000 / 14 / EC.**

Conditii ambientale de referinta: 1000 mbar; 25°C; 30% umiditate relativa; putere in conformitate cu normativele ISO 3046 / ISO 8528.

#### **Prime power (PRP) – ISO 8528**

Prime power (PRP) - reprezinta puterea continua pe care un grup electrogen este capabil sa o asigure în mod continuu în timp ce alimentează o sarcină electrică variabilă, atunci când funcționează pentru un număr nelimitat de ore pe an, în condițiile de exploatare convenite, intervalele de mentenanță și procedurile fiind efectuate în modul stabilit de către producător.

#### **Standby power (ESP) – ISO 8528**

Standby power (ESP) reprezinta puterea maximă disponibilă la o sarcina variabilă, în condițiile de funcționare prevăzute, pe care un grup electrogen este capabil sa o asigure, în caz de pană de curent sau în condiții de testare, intervalele și procedurile de mentenanță fiind efectuate în modul stabilit de producător.

#### **S.C. Endress Zenessis Group S.R.L.**

##### **Birouri:**

Bucuresti: km 16 A1 – Ciorogarla, Sos. Bucuresti, Nr. 108  
D38486 Apenburg - Winterfeld, In Altensalzwedel 49

##### **Productie:**

Romania, Bocsa, Str. Medresului, Nr. 17, jud. Caras – Severin.

**1. MOTOR DIESEL**

SPECIFICATII MOTOR	
Tip	IVECO Stage III
Model	N45SM1F
Nr. cilindri & dispunere	4 in linie
Sistem injectie	Directa cu turbina si intercooler
Sistem racire	Cu lichid
Putere maxima standby (kWm)	62
Turatie (rpm)	1500
Cilindree (l)	4.5
Diametru interior & cursa (mm)	104 x 132
Factor compresie	17,5:1
Regulator	Mecanic
Capacitate totala ulei (l)	12.8
Capacitate agent racire motor (l)	18.5
Consum combustibil la sarcina 100% in regim prime (l / h)	16.7

**2. ALTERNATOR**

SPECIFICATII ALTERNATOR		Strathon / Leroy Somer
Model	ECO 68 KW / TAL042	
Frecventa (Hz)	50	
Concept	Fara perii, cu 4 poli	
Faze	3 + n	
Tensiune (V)	400 / 230	
Clasa izolatie	H	
Sistem excitatie	Electronic	
Randament	93%	
Grad protectie	IP23	
Certificare Test	EN 10204 : 2001	

**3. PANOUL COMANDA**

Realizat in cutie metalica, cu grad de protectie IP54, prevazut cu incuietoare. Panoul comanda este dotat cu modul de comanda ComAp Inteli Lite<sup>NT</sup> AMF25, prevazut cu posibilitate de pornire si oprire grup electrogen, atat in modul automat cat si in modul electric. Modulul de comanda monitorizeaza reseaua electrica si poate comanda si controla panoul AAR (aclansarea automata a rezervei).

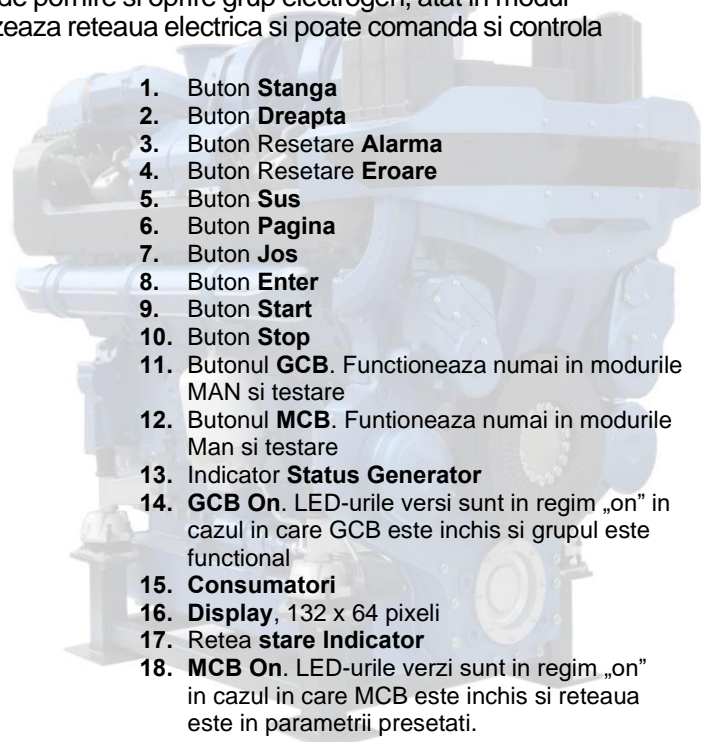
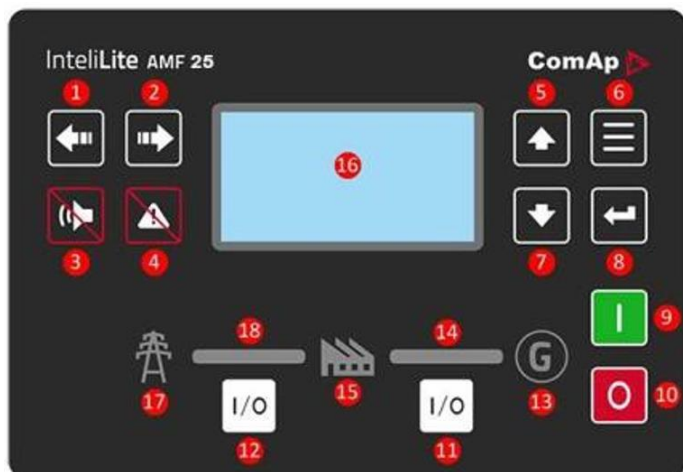

1. Buton **Stanga**
2. Buton **Dreapta**
3. Buton Resetare **Alarma**
4. Buton Resetare **Eroare**
5. Buton **Sus**
6. Buton **Pagina**
7. Buton **Jos**
8. Buton **Enter**
9. Buton **Start**
10. Buton **Stop**
11. Butonul **GCB**. Functioneaza numai in modurile MAN si testare
12. Butonul **MCB**. Functioneaza numai in modurile Man si testare
13. Indicator **Status Generator**
14. **GCB On**. LED-urile versi sunt in regim „on” in cazul in care GCB este inchis si grupul este functional
15. **Consumatori**
16. **Display**, 132 x 64 pixeli
17. **Retea stare Indicator**
18. **MCB On**. LED-urile verzi sunt in regim „on” in cazul in care MCB este inchis si reseaua este in parametrii presetati.

**◆ Specificatii standard panou comanda:**

Panoul de comanda si control este montat in interiorul carcasei , in cutie metalica cu IP 54, prevazut cu geam pentru vizualizare, dotat cu:

- Modul comanda Inteli Lite<sup>NT</sup> AMF 25
- Incarcator baterie static
- Buton oprire de urgenta & sigurante pt. controlul circuitelor
- Protectie diferentiala supracurent
- Relee protectie

**• Configuratie:**

1. Modul comanda Inteli Lite<sup>NT</sup> AMF 25
2. Protectie CB- disjunctor
3. Incuietoare
4. Alarma sonora
5. Buton START ON / OFF
6. Balamale
7. Grafic mentenanta
8. Cutie metalica

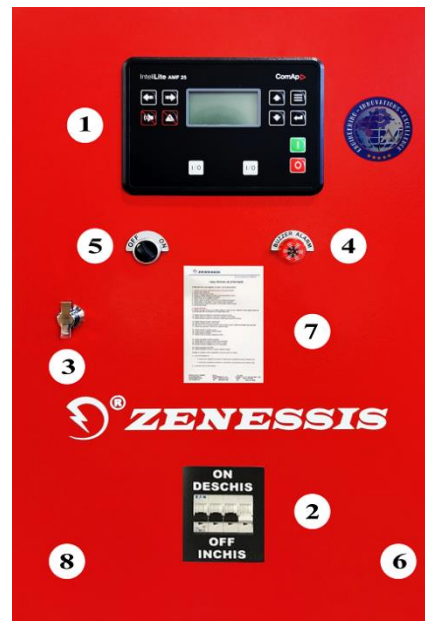
**◆ Specificatii standard modul comanda:**

- Control prin microprocesor
- Display LCD 132 x 64 pixeli
- Posibilitate de programare pe panoul frontal cat si prin intermediul softului PC
- Butoane control si navigare soft touch
- Comunicare la distanta prin intermediul mufei USB sau optional prin intermediul RS232, RS485, Ethernet sau mesaj sms
- Memorare 180 evenimente cu data si ora
- Programare mentenanta 3 nivele
- Controlul incalzitorului motorului –optional

**• Afisaje:**

**Motor:** turatie motor; presiune ulei; temperatura agent racire; timp functionare; tensiune baterie; data mentenanta.

**Alternator:** tensiune (L – L, L – N); curent (L1 – L2 – L3); frecventa, putere activa kW, putere aparenta kVA, putere reactiva kVA r, factor putere, secventa faze.

**Retea principala:** tensiune (L – L, L – N); frecventa; retea principala pregatita; retea principala decuplata; grup electrogen pregatit; grup electrogen decuplat, , putere activa kW, putere aparenta kVA, putere reactiva kVA r, factor putere, secventa faze.

- **Atentionari:** incarcare defecta baterie, tensiune scazuta baterie, oprire ratata, nivel scazut combustibil, suprasarcina, inversare faza, defect senzor turatie.
- **Alarmer:** presiune scazuta ulei, temperatura ridicata motor, sub/supraturatie, sub/suprafrecventa, sub/supratensiune, ECU defect-optional.
- **Afisari de stare:** start ratat, oprire urgenta, presiune scazuta ulei, temperatura ridicata motor, sub/supraturatie, sub/suprafrecventa, sub/supratensiune, senzor defect ulei, rotirea fazelor, suprasarcina, supracurent grup, inversare faze.

**◆ Incarcator static baterie:** fabricat cu tehnologie TSD, cu inalta eficienta. Protejat pentru curenti de scurtcircuit, poate fi folosit ca o sursa de curent, tensiune intrare 196-264 V, tensiune iesire 27,6 V/ 5A sau 13,8 V/ 5A

**◆ Standarde:**

Compatibilitate EMC; BS EN 60950; BS EN 60950 – 6 – 2 EMC; BS EN 61000 – 6 – 4 EMC.

### 4. CARCASA

Realizata din tabla zincata, vopsita in camp electrostatic, insonorizata acustic, material ignifug. Este proiectata modular cu usi de acces in interior pe toate laturile generatorului. Toba de esapament este de tip rezidential, montata in interiorul carcasei.

Carcasele sunt proiectate pentru a optimiza racirea ansamblului motor si alternator, putand fi montate in exterior, asigurand o protectie impotriva intemperiiilor , si un nivel de zgomot redus. Vopsirea este realizata cu vopsea poliuretunica, cu protectie impotriva UV.

1. Modul comanda
2. Usa acces modul comanda
3. Usa acces motor si alternator
4. Ocheti ridicare macara
5. Tava retentie lichide (optional)
6. Capac radiator
7. Grilaj evacuare aer cald
8. Manere prevazute cu incuietori
9. Gauri ridicare / tragere
10. Sasiu
11. Buton avarie
12. Clapeta evacuare gaze esapament
13. Spatiu acces cabluri
14. Grilaj admisie aer
15. Tampoane protectie

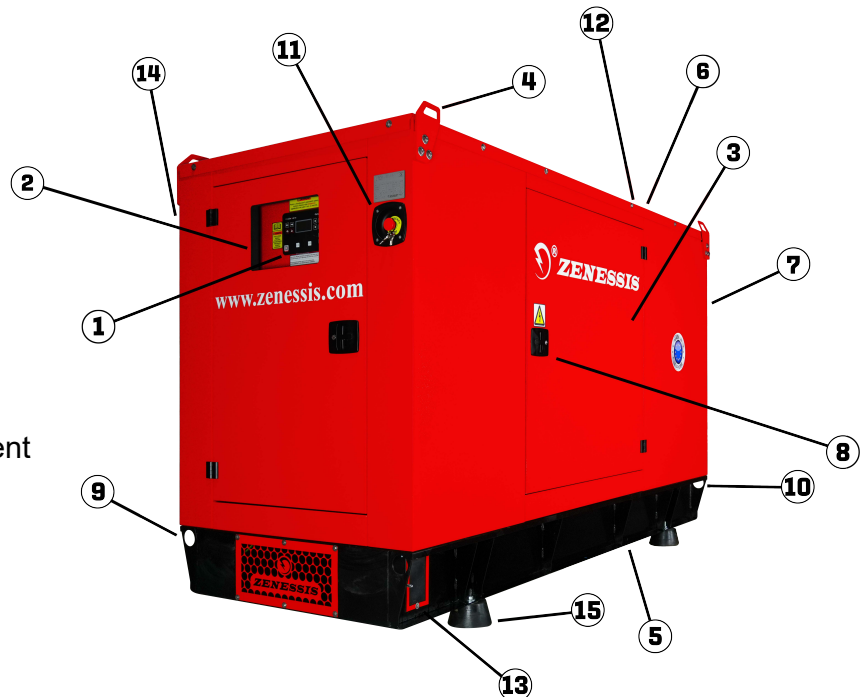

### 5. DIMENSIUNI & GREUTATE

Dimensiuni & greutate grup electrogen deschis	
Dimensiuni (lungime x latime x inaltime) (mm)	2300 x 1010 x 2000
Greutate uscat (kg)	1200
Capacitate rezervor combustibil (litri)	200
Nivel zgomot in ambient (la distanta de 7m)	82 db
Dimensiuni & greutate grup electrogen inchis	
Dimensiuni (lungime x latime x inaltime) (mm)	2700 x 1010 x 1700
Greutate uscat (kg)	1750
Capacitate rezervor combustibil (litri)	200
Nivel zgomot in ambient (la distanta de 7m)	70 db

### 6. DOTARI STANDARD

Panou control & comanda cu masuratori & dispozitive de control metalic, grad protectie IP 54



Incalzitor termostatat comandat pt. lichidul de racire



Incarcator static pt. acumulator



Acumulator pornire supradimensionat



Alternator dinamic incarcare acumulatori



Buton oprire urgenta



Sasiu cu rezervor combustibil dimensionat pt. 8 ore autonomie



Tampoane protectie



Amortizoare antivibratii

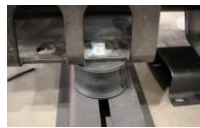

Balamale metalice



Dispozitiv masurare nivel combustibil



Usi acces prevazute cu incuietori



Trasee electrice protejate cu tubulatura & presetupa



Sistem pentru manipularea cu macaraua sau cu motostivitorul



Toba esapament rezidentiala



Capitonaj antifonic ignifug

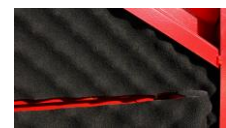

### 7. DOTARI OPTIONALE

Sistem incalzire anticondens. tablouri electrice



Tava retentie lichide



Sistem incalzire combustibil / ulei



Senzor detectie scurgeri lichide



Pompa circulatie incalzire lichid racire



Sistem monitorizare & comanda la distanta



Pompa evacuare ulei



Buson exterior alimentare combustibil cu incuietorie



AAR motorizat, inventie brevetata ENDRESS– Brevet OSIM 00048 / 2015



Sistem buzunare pentru ridicare cu stivitor integrati in sasiu



Tablou transfer AAR cu 3/4 poli



Instinctor cu suport interior carcusei



Protectie diferentiala cu 3/4 poli



Carcasa superinsonorizata



Prize 400 V/ 230 V



Bujie incalzire aer admisie



Filtru combustibil cu detectie apa



Electrozi impamantare



Tablou ocolire – inventie  
brevetata ENDRESS – Brevet  
OSIM 00010 / 2012



Pompa automata transfer  
combustibil



Remorca auto



Panou mobil distributie cu 4  
prize



Pornire prin telecomanda



Tambur cablu



Protectie lipsa impamantare



Detector incendiu cu oprire  
automata grup electrogen



Iluminat interior cu  
intreruptoare actionate la  
deschidere usi



Sistem stingere incendii cu  
gaz inert



**Optional: Remorca auto omologata RAR**

**Model remorca EGR 1350**

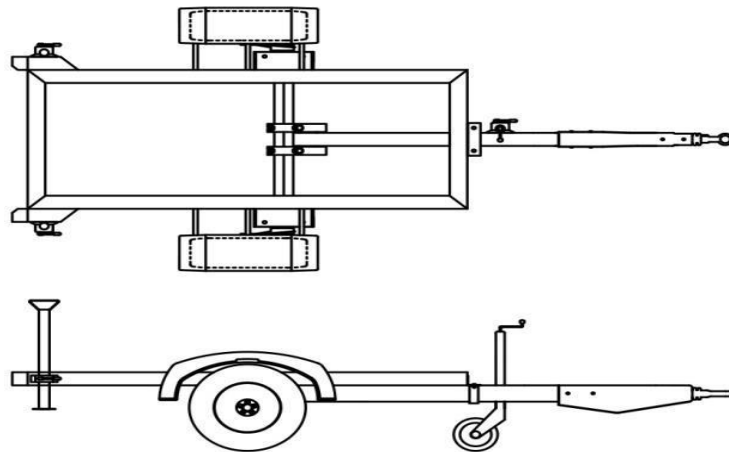

**Create in Germania – Asamblate in Romania  
Garantie: 36 luni sau 3000 ore de functionare.**

**PRODUSELE ENDRESS SUNT INTR-UN PERMANENT PROCES DE DEZVOLTARE SI  
PERFECTIONARE. DIN ACEST MOTIV, ENDRESS ZENESSIS GROUP ISI REZERVA DREPTUL  
DE A MODIFICA DATELE DIN ACESTE PLIANTE FARA O INFORMARE PREALABILA.**